

General Description

The Gotop GAM-1818-MTR is a complete GPS engine module that features super sensitivity, ultra low power and small form factor. The GPS signal is applied to the antenna input of module, and a complete serial data message with position, velocity and time information is presented at the serial interface with NMEA protocol or custom protocol.

Its -165dBm tracking sensitivity extends positioning coverage into place like urban canyons and dense foliage environment where the GPS was not possible before. The small form factor and low power consumption make the module easy to integrate into portable device like PNDs, mobile phones, cameras and vehicle navigation systems.

Applications

- LBS (Location Based Service)
- PND (Portable Navigation Device)
- Vehicle navigation system
- Mobile phone



Figure1: GAM-1818-MTR Top View

Features

- Build on high performance, low-power MediaTek MT3337 chip set
- Ultra high Track sensitivity: -165dBm
- Extremely fast TTFF at low signal level
- Built in high gain LNA
- Low power consumption: Max $28\text{mA}@3.3\text{V}$
- NMEA-0183 compliant protocol or custom protocol
- Operating voltage: 2.8V to 4.3V
- Operating temperature range: -40 to 85°C
- Patch Antenna Size: $18 \times 18 \times 4\text{mm}$
- Module Size: $18.1 \times 18.1 \times 6.41\text{mm}$
- Communication type: UART/TTL
- RoHS compliant (Lead-free)

1 Description

1.1. Key Features

Parameter	Specification
Power Supply	<ul style="list-style-type: none"> Supply voltage: 2.8V~4.3V Typical: 3.3V
Power Consumption	<ul style="list-style-type: none"> Acquisition: 28mA @VCC=VBAT=3.3V Tracking: 20mA @VCC=VBAT=3.3V Standby: 1.0mA @VCC=VBAT=3.3V Backup: 15uA @VBAT=3.3V
Receiver Type	<ul style="list-style-type: none"> Code 66 search channels, GPS&QZSS L1 1575.42MHz C/A 22 simultaneous tracking channels
Sensitivity	<ul style="list-style-type: none"> Tracking: -165dBm Re-acquisition: -156dBm Acquisition: -148dBm
TTFF (Autonomous)	<ul style="list-style-type: none"> Cold start: 35s typ @-130dBm Warm start: 30s typ @-130dBm Hot start: 1s typ @-130dBm
Horizontal Position Accuracy (Autonomous)	<ul style="list-style-type: none"> <2.5m CEP @-130 dBm
Update Rate	<ul style="list-style-type: none"> 1Hz
Accuracy of 1PPS Signal	<ul style="list-style-type: none"> not enabled
Acceleration Accuracy	<ul style="list-style-type: none"> Without aid: 0.1m/s²
Dynamic Performance	<ul style="list-style-type: none"> Maximum altitude: 18,000m Maximum velocity: 515m/s Acceleration: 4G
UART Port	<ul style="list-style-type: none"> UART Port: TXD and RXD Supports baud rate from 4800bps to 115200bps, 9600bps by default UART port is used for NMEA output, MTK proprietary commands input
Temperature Range	<ul style="list-style-type: none"> Normal operation: -40°C ~ +85°C Storage temperature: -45°C ~ +125°C
Physical Characteristics	<ul style="list-style-type: none"> Size: 18.1±0.20 ×18.1±0.20 ×6.41±0.20mm Weight: Approx. 7.6g

1.2 Power Supply

Regulated power for the GAM-1818-MTR is required. The VCC Pin Need a stable DC voltage supply. Power supply ripple must be less than 30mV. The input voltage Vcc should be 2.8V~4.3V, Recommended power supply voltage is 3.3V . maximum current is 20mA. Suitable decoupling must be provided by external decoupling circuitry.

1.3 UART Ports

The module supports two full duplex serial channels UART. All serial connections are at 3V CMOS logic levels, if need different voltage levels, use appropriate level shifters. The baud rate of both serial ports are fully programmable, the data format is however fixed: X, N, 8, 1, i.e. X baud rate, no parity, eight data bits and one stop bit, no other data formats are supported, LSB is sent first. The modules default baud rate is set up 9600bps, however, the user can change the default baud rate to any value from 4800 bps to 115kbps. UART port can be used for firmware upgrade, NMEA output and PMTK proprietary commands input.

2 Application

The module is equipped with a 5-pin pad that connects to your application platform. The GAM-1818-MTR module It consists of a MediaTek MT3337 single chip GPS IC which includes the RF part and Baseband part, a patch antenna, a LNA, a SAW filter, a TCXO, a crystal oscillator.

2.1. Pin Assignment

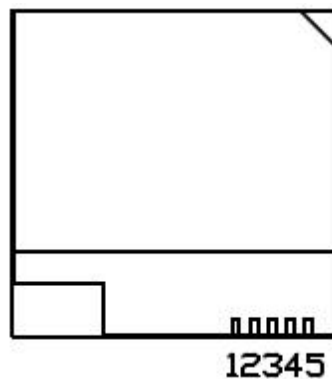

Figure 2: Pin Assignment

CON Pin Description

Pin No.	Pin name	I/O	Description	Remark
1	VBAT	I	RTC Battery Input	Voltage range: 1.5V~4.3V
2	TXD	O	UART Serial Data output	
3	RXD	I	UART Serial Data Input	
4	VCC	I	Module Power Supply	Voltage range: 2.8V~4.3V
5	GND	G	Ground	

2.2 Mechanical Dimensions

This chapter describes the mechanical dimensions of the GAM-1818-MTR module. Size unit (mm)

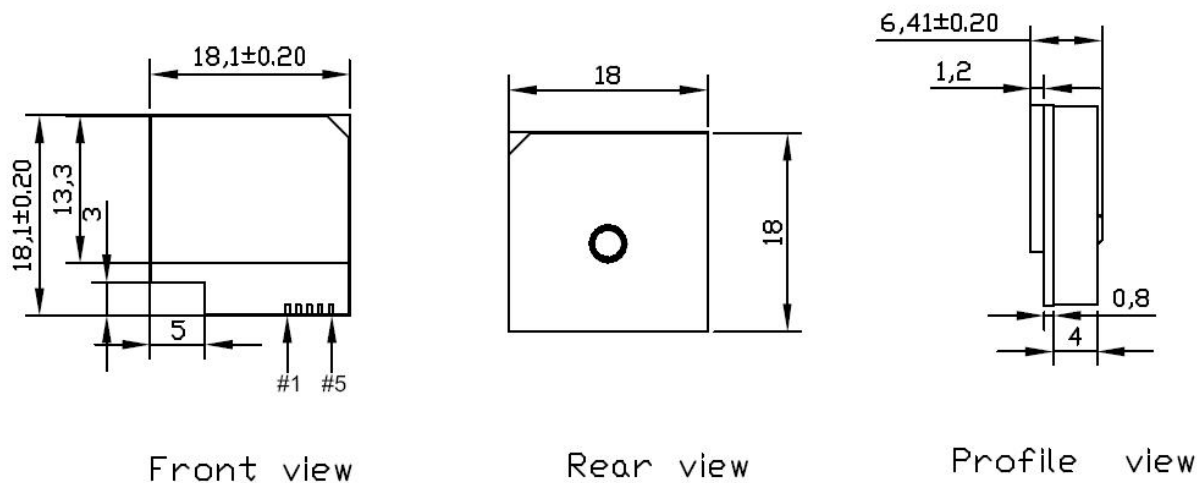

Figure 3: Specification size chart

3 NMEA 0183 Protocol

The NMEA protocol is an ASCII-based protocol, Records start with a \$ and with carriage return/line feed. GPS specific messages all start with \$GPxxx where xxx is a three-letter identifier of the message data that follows. NMEA messages have a check sum, which allows detection of corrupted data transfers.

The Gotop GAM-1818-MTR supports the following NMEA-0183 messages: \$GPGGA, \$GPGLL,\$GPGSA,\$GPSV, \$GPRMC and \$GPVTG.

Table 1: NMEA-0183 Output Messages

NMEA Record	DESCRIPTION
GGA	Global positioning system fixed data
GLL	Geographic position—latitude/longitude
GSA	GNSS DOP and active satellites
GSV	GNSS satellites in view
RMC	Recommended minimum specific GNSS data
VTG	Course over ground and ground speed

3.1 GGA-Global Positioning System Fixed Data

\$GPGGA, 161229.487,3723.2475,N, 12158.3416,W, 1,07,1.0,9.0,M.0000*18

Table 2: GGA Data Format

Name	Example	Units	Description
Message ID	\$GPGGA		GGA protocol header
UTC Position	161229.487		hhmmss.sss
Latitude	3723.2457		ddmm.mmmm
N/S indicator	N		N=north or S=south
Longitude	12158.3416		dddmm.mmmm
E/W Indicator	W		E=east or W=west
Position Fix Indicator	1		See Table 2-1
Satellites Used	07		Range 0 to 12
HDOP	1.0		Horizontal Dilution of Precision
MSL Altitude	9.0	meters	
Units	M	meters	
Geoids Separation		meters	
Units	M	meters	
Age of Diff.Corr.		second	Null fields when DGPS is not Used
Diff.Ref.Station ID	0000		
Check sum	*18		
<CR> <LF>			End of message termination

Table 2-1: Position Fix Indicators

Value	Description
0	Fix not available or invalid
1	GPS SPS Mode, fix valid
2	Differential GPS, SPS Mode, fix valid
3	GPS PPS Mode, fix valid

3.2 GLL-Geographic Position - Latitude/Longitude

\$GPGLL , 3723.2475, N,12158.3416, W,161229.487, A*2C.

Table 3: GLL Data Format

Name	Example	Units	Description
Message ID	\$GPGLL		GLL protocol header
Latitude	3723.2475		ddmm.mmmm
N/S Indicator	N		N=north or S=south
Longitude	12158.3416		dddmm.mmmm
E/W Indicator	W		E=east or W=west
UTC Position	161229.487		hhmmss.sss
Status	A		A=data valid or V=data not valid
Check sum	*2C		
<CR> <LF>			End of message termination

3.3 GSA-GNSS DOP and Active Satellites

\$GPGSA , A, 3, 07, 02, 26,27, 09, 04,15, , , , , , 1.8,1.0,1.5*33.

Table 4: GSA Data Format

Name	Example	Units	Description
Message	\$GPGSA		GSA protocol header
Mode 1	A		See Table 4-2
Mode 2	3		See Table 4-1
Satellite Used	07		Sv on Channel 1
Satellite Used	02		Sv on Channel 2
...
Satellite Used			Sv on Channel 12
PDOP	1.8		Position Dilution of Precision
HDOP	1.0		Horizontal Dilution of Precision
VDOP	1.5		Vertical Dilution of Precision
Check sum	*33		
<CR> <LF>			End of message termination

Table 4-1

Value	Description
1	Fix not available
2	2D
3	3D

Table 4-2

Value	Description
M	Manual-forced to operate in 2D or 3D mode
A	Automatic-allowed to automatically switch 2D/3D

3.4 GSV-GNSS Satellites in View

\$GPGSV , 2, 1, 07, 07, 79,048, 42, 02, 51,062, 43, 26, 36,256, 42, 27, 27, 138,42*71

\$GPGSV, 2, 2, 07, 09, 23,313, 42, 04, 19, 159, 41, 15,12,041, 42*41.

Table 5: GGA Data Format

Name	Example	Units	Description
Message ID	\$GPGSV		GSV protocol header
Number of Message	2		Range 1 to 3
Message Number	1		Range 1 to 3
Satellites in View	07		
Satellite ID	07		Channel 1(Range 1 to 32)
Elevation	79	degrees	Channel 1(Maximum 90)
Azinmuth	048	degrees	Channel 1(True, Range 0 to 359)
SNR(C/NO)	42	dBHz	Range 0 to 99,null when not tracking
...			...
Satellite ID	27		Channel 4(Range 1 to 32)
Elevation	27	degrees	Channel 4(Maximum 90)
Azimuth	138	degrees	Channel 4(True, Range 0 to 359)
SNR(C/NO)	42	dBHz	Range 0 to 99, null when not tracking
Check sum	*71		
<CR> <LF>			End of message termination

✧ Depending on the number of satellites tracked multiple messages of GSV data may be required.

3.5 RMC-Recommended Minimum Specific GNSS Data

\$GPRMC, 161229.487, A, 3723.2475, N, 12158.3416, W, 0.13,309.62, 120598,, *10

Table 6: RMC Data Format

Name	Example	Units	Description
Message ID	\$GPRMC		RMC protocol header
UTS Position	161229.487		hhmmss.sss
Status	A		A=data valid or V=data not valid
Latitude	3723.2475		ddmm.mmmm
N/S Indicator	N		N=north or S=south
Longitude	12158.3416		dddmm.mmmm
E/W Indicator	W		E=east or W=west
Speed Over Ground	0.13	Knots	
Course Over Ground	309.62	Degrees	True
Ground			
Date	120598		dummy
Magnetic variation		Degrees	E=east or W=west
Check sum	*10		
<CR> <LF>			End of message termination

3.6 VTG-Course Over Ground and Ground Speed

\$GPVTG, 309.62, T, M, 0.13, N, 0.2, K*6E

Table 7: VTG Data Format

Name	Example	Units	Description
Message ID	\$GPVTG		VTG protocol header
Course	309.62	Degrees	Measured heading
Reference	T		True
Course		Degrees	Measured heading
Reference	M		Magnetic
Speed	0.13	Knots	Measured horizontal speed
Units	N		Knots
Speed	0.2	Km/hr	Measured horizontal speed
Units	K		Kilometer per hour
Check sum	*6E		
<CR> <LF>			End of message termination

©Copyright 2016 Gotop Technology Co., Ltd. All Right Reserved

The information contained herein is subject to change without notice.

Gotop Technology Co. , LTD

Add:Room 603 Zhantao Technology Building,Minzhi Road,Xinniu Communnity,Minzhi Street, Baoan District, ShenZhen City China.

Phone: 86-755-23804156

fax: 86-755-23804155

N 22° 32' 17", E 114° 07' 07"

<http://www.gotop-zzu.com>

Not to be reproduced in whole or part for any purpose without written permission of Gotop Technology Inc ('Gotop'). Information provided by Gotop is believed to be accurate and reliable. These materials are provided by Gotop as a service to its customers and may be used for informational purposes only. Gotop assumes no responsibility for errors or omissions in these materials, nor for its use. Gotop reserves the right to change specification at any time without notice.

These materials are provides 'as is' without warranty of any kind, either expressed or implied, relating to sale and/or use of Gotop products including liability or warranties relating to fitness for a particular purpose, consequential or incidental damages, merchantability, or infringement of any patent, copyright or other intellectual property right. Gotop further does not warrant the accuracy or completeness of the information, text, graphics or other items contained within these materials. Gotop shall not be liable for any special, indirect, incidental, or consequential damages, including without limitation, lost revenues or lost profits, which may result from the use of these materials.

Gotop products are not intended for use in medical, life-support devices, or applications involving potential risk of death, personal injury, or severe property damage in case of failure of the product.